

HARVEY LINE DESIGN RODOLFO DORDONI



Più che un'evoluzione, una trasformazione. Harvey resta quello che è. Solo ha un'alternativa, si chiama Harvey Line. Nuovi sono i colori della laccatura, nuove le performance e le misure. Ma è più in basso la variante che incide davvero sul carattere. Cambia la base, dopo il legno troviamo il metallo. Ma un metallo che emana intimità: finitura Peltro, semplice e lineare.

Struttura: in legno spessore mm 20, top assemblato a 45° alle spalle laterali. Ante in legno, spessore mm 30, con maniglia incassata in metallo, finitura Black-Nickel. Cassetti con guide "Blue - Motion", finitura interna rovere laccato moka a poro aperto e maniglia in metallo, finitura Black-Nickel. Ripiano in vetro fumè mm 10, posto all'interno dei moduli ad ante.

Finiture: struttura esterna e ante completamente laccate lucido nei colori: grigio stone, moka, bianco, sand, fango, granito o petrolio (finitura interna della struttura laccata opaco in tinta con la finitura esterna) oppure in rovere laccato moka a poro aperto.

Modulo HI-FI dotato di:

- 1 vano porta lettore DVD-CD (misura interna cm 90x45 H14);
- 1 ampio cassetto (misura interna cm 86x37 H12);
- 1 contenitore con 3 scomparti (misura interna cm 27x37 H6). L'ampio cassetto e il contenitore scorrono su guide a estrazione totale con chiusura "Blue - Motion".

Base: appoggio a terra tramite base in metallo da mm 10x50 laccata semilucida color Peltro (tonalità ideata da Minotti Studio) e piedini tecnici regolabili.

A transformation, rather than an evolution. Harvey remains what it is. Only it has an alternative, called Harvey Line. New lacquered colours, new performances and new sizes. However, the variant that really has an impact on the character is lower. The base has changed; wood has been followed by metal, a type of metal which exudes intimacy: Pewter finish, simple and linear.

Structure: in wood mm 20 in thickness, top mounted, at an angle of 45°, to sides. Wood doors mm 30 in thickness, with built-in metal handles, Black-Nickel finish. Drawers with "Blue - Motion" guides; interior open-pore Moka lacquered oak finish, metal handles Black-Nickel finish. Smoked grey glass shelves mm 10 in thickness, in door modules.

Finishes: body and doors glossy lacquered in stone grey, Moka, white, sand, mud, granite and petroleum colours (interior matt lacquered finish matching exterior finish in colour) or in open pore Moka lacquered oak.

HI-FI Module composed of:

- 1 DVD-CD player compartment (interior dimensions cm 90x45 H14);
- 1 wide drawer (interior dimensions cm 86x37 H12);
- 1 three-compartment cabinet (interior dimensions cm 27x37 H6). The large drawer and the cabinet are mounted on full extraction guides with "Blue - Motion" closure.

Base: metal base mm 10x50 lacquered in semigloss pewter colour (shade devised by Minotti Studio) and adjustable technical feet.

Statt Entwicklung, Transformation. Harvey bleibt so wie er ist. Es gibt jedoch eine Alternative - die Harvey Line. Neu sind die Lackfarben, die Performance und Abmessungen. Die eigentliche und den Charakter beeinflussende Veränderung spielt sich aber im unteren Bereich ab. Das Gestell ändert sich. Nach dem Holz finden wir nun Metall. Dieses Metall vermittelt jedoch Intimität: zinnfarbenes Finish, einfach und linear.

Struktur: mit einem 20 mm dickem Holzgestell, 45°-Montage des Ablageelements an den Seitenwänden. Holzflügel, Dicke 30 mm mit eingelassenem Metallgriff, Black-Nickel-Finish. Schubladen mit "Blue - Motion" Führungen, Innenfinish aus Eiche, offenporig lackiert in Mokka, und Metallgriff im Black-Nickel-Finish. Einlegeboden in den Flügelmodulen aus 10 mm Rauchglas.

Ausführungen: Grundgestell und Flügel mit Glanzlackierung in den Farben Steingrau, Mokka, Weiß, Sand, Schlamm, Granit oder Petroleum (Innen matt lackiert und passend zum Außenfinish) oder aus offenporig in Mokka lackiertem Eichenfurnier.

HI-FI Modul besteht aus:

- 1 Fach für den DVD-CD-Player (Innenabmessung cm 90x45 H14);
- 1 große Schublade (Innenabmessung cm 86x37 H12);
- 1 Schrankelement mit drei Fächern (Innenabmessung cm 27x37 H6). Die große Schublade und das Schrankelement gleiten auf komplett herausziehbaren Führungen mit "Blue - Motion" Verschluss.

Gestell: die Auflage auf dem Boden erfolgt durch ein 10 x 50 mm starkes Metallgestell mit zinnfarbenem Halbglanz-Lack-Finish und technische (von Minotti Studio erfundener Farbton), höhenverstellbare Füße.

L'épaisseur de 7 cm est celle de toujours, il y a en revanche trois nouvelles couleurs de laqueage pour les dossiers. Quant aux performances conceptuelles, deux mots suffisent : liberté d'interprétation. Ce qui signifie ouvrir le projet à des possibilités infinies, de le rendre capable de traverser les multiples idées de meuble et de les dépasser.

Structure : en bois de mm 20 d'épaisseur, plateau assemblé à 45° aux épaulements latéraux. Portes en bois, épaisseur mm 30 avec poignée encastrée en métal, finition Black-Nickel. Tiroirs avec glissières "Blue - Motion", finition interne rouvre laqué Moka à pore ouvert et poignée en métal, finition Black-Nickel. Tablette en verre 10 mm fumé, située à l'intérieur des modules à portes.

Finition : coque et portes laquées brillantes dans les couleurs gris stone, moka, blanc, sand, boue, granit ou pétrole (finition interne laquée mate assortie à la teinte externe) ou bien en rouvre laquée moka à pore ouvert.

RMQ : finition interne laquée mate en teinte avec la finition externe.

Module HI-FI comprend:

- 1 emplacement porte-lecteur DVD-CD (mesure interne cm 90x45 H14);
- 1 grand tiroir (mesure interne cm 86x37 H12);
- 1 rangement à 3 compartiments (mesure interne cm 27x37 H6). Le grand tiroir et le rangement coulissent sur des glissières à extraction totale et sont munis de fermeture "Blue - Motion".

Base : piètement avec base en métal mm 10x50 mm laquée semi-brillante couleur Étain (tonalité conçue par Minotti Studio) et pieds techniques réglables.

STRUTTURA | STRUCTURE

ROVERE | OAK



LACCATO LUCIDO | GLOSSY LACQUERED

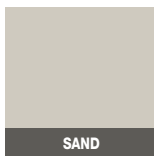

BASE

ROVERE | OAK

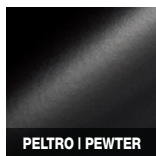

Minotti

HARVEY LINE H101

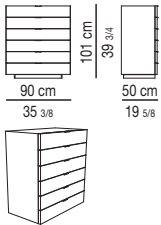
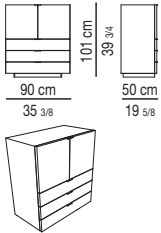
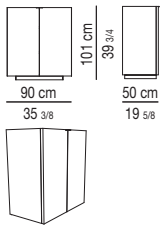

HARVEY LINE HI-FI H53

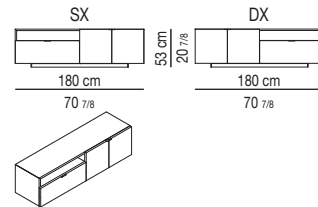
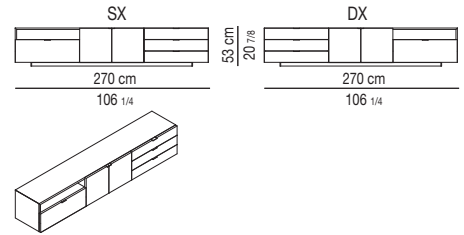
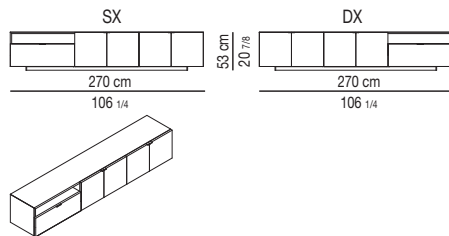
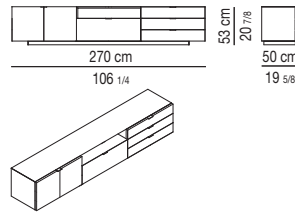
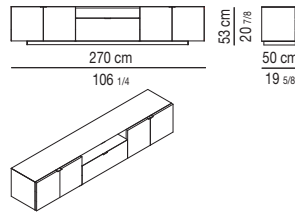

NEW

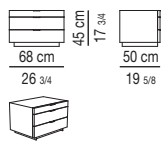

PASSACAVI | GRUMMET

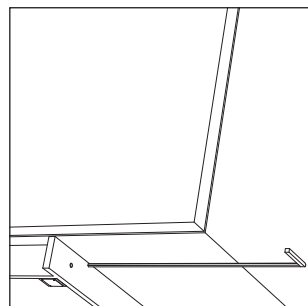
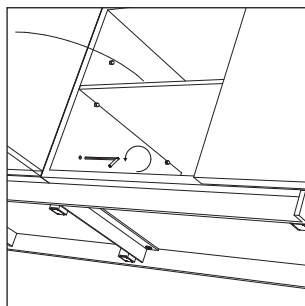

SISTEMA DI REGOLAZIONE DEI PIEDINI | REGULATION FEET SYSTEM

HARVEY LINE H74

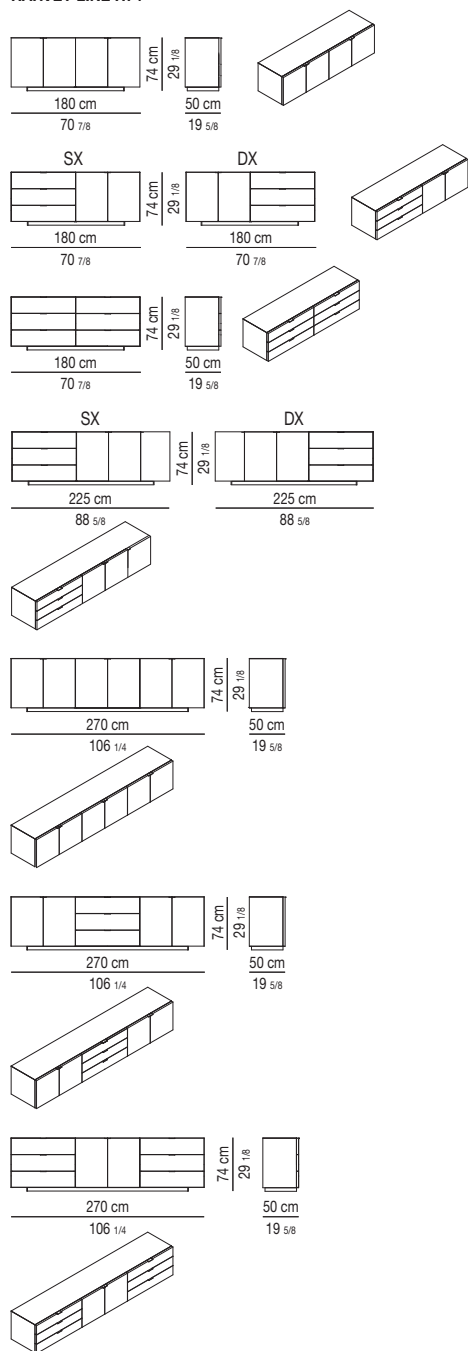

HARVEY LINE H53

